



BLÜCHER

WATERLINE DESIGN DRAINS

STAINLESS STEEL DRAINAGE SYSTEMS

- Contemporary and stylish design
- Easy to fit into the floor tiling
- Adjustable
- Easy maintenance

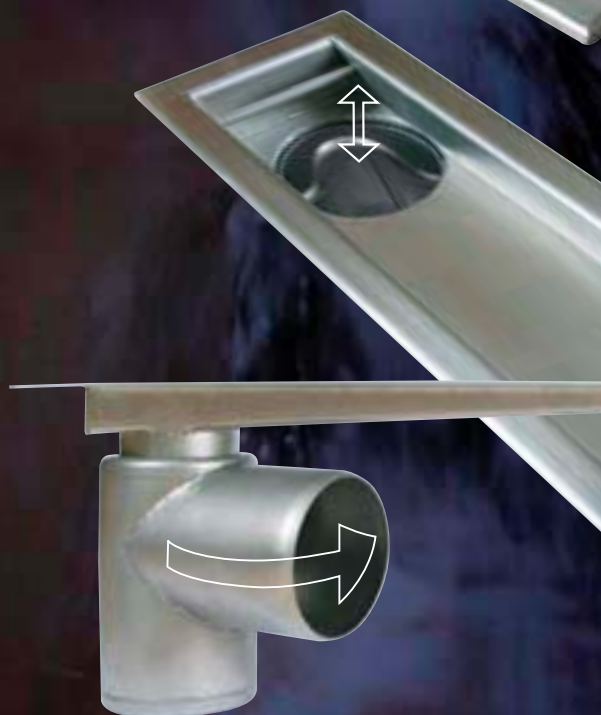



BLÜCHER WaterLine

BLÜCHER WATERLINE DESIGN DRAINS

PATENT APPLIED FOR

Stylish floor drainage

- matching modern bathroom design

Round-hole grating

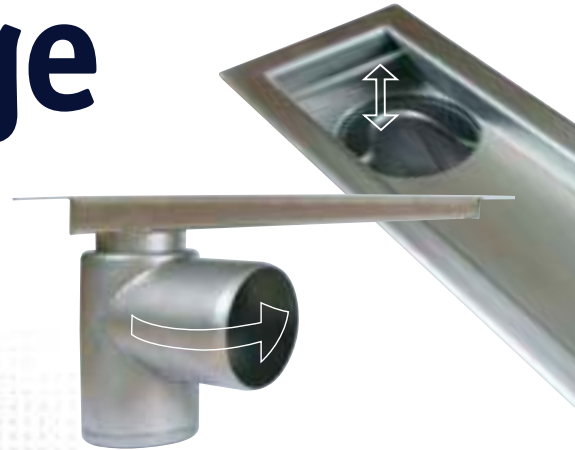

BLÜCHER WaterLine shower channel

- Available in lengths 300, 700, 800, 900 and 1000 mm
- Channel width 82 mm including 15 mm frame to each side
- For installation either against a wall, in the middle of the shower area, at the entrance to an enclosed shower, or indeed wherever you choose
- Custom trap can be cleaned easily, with removal of the standpipe it can be used as a rodding outlet
- Trap outlet can rotate 360° aiding installation
- Option of weep gap
- Grate retaining bar acting as a rat stop
- Comes with round-hole grating or annular grating

BLÜCHER WaterLine triangle drain

- Can either fit into a corner or along one edge of the floor
- Dimensions 277 mm (short sides) and 388 mm (long side) on triangle drain for installation in corner
- Fits perfectly into a diamond pattern floor
- Adjustable height
- Can be used with a large range of BLÜCHER Domestic® lower parts allowing a host of options from low height to inlets for other bathroom waste
- The BLÜCHER removable water trap can be fitted to most of the lower parts used with the triangle drain
- Grating and trap are removable allowing access for rodding
- Comes with round-hole grating, "O" grating available as a separate grating

ED



Annular grating

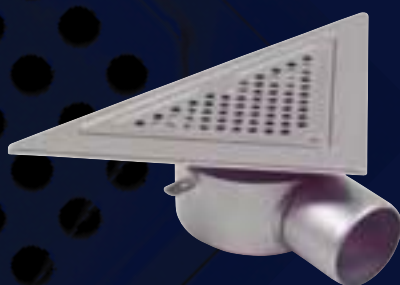

"O" grating

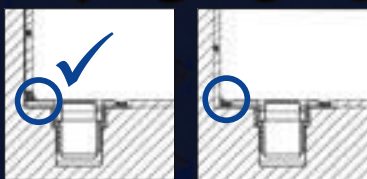

The frame has been designed with an extra wide flange to ensure that the joint between flange and wall tiles is placed "in the wall".

BLÜCHER WaterLine design drains

- Developed to meet the highest design aspirations without compromising on function
- All in stainless steel
- Mechanically finished gratings and edges retaining their bright look for years
- Hygienic and easy to keep clean
- No complex floor falls, reducing installation time and costs
- Approved for use in wet rooms in accordance with the strict Scandinavian building regulations



Round-hole grating

TYPES 171 AND 371



Type no. without flange	L	Type no. with flange	L	X1	X2	X3	X4
171.070.056.2A	694	371.070.056.2A	700	15	30	30	30
171.070.056.2B	694	371.070.056.2B	700	15	30	30	30
171.080.056.2A	794	371.080.056.2A	800	15	30	30	30
171.080.056.2B	794	371.080.056.2B	800	15	30	30	30
171.090.056.2A	894	371.090.056.2A	900	15	30	30	30
171.090.056.2B	894	371.090.056.2B	900	15	30	30	30
171.100.056.2A	994	371.100.056.2A	1000	15	30	30	30
171.100.056.2B	994	371.100.056.2B	1000	15	30	30	30

TYPES 175 AND 375

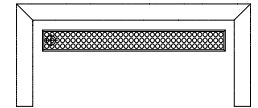

Type no. without flange	L	Type no. with flange	L	X1	X2	X3	X4
175.070.056.2A	664	375.070.056.2A	700	15	15	15	15
175.070.056.2B	664	375.070.056.2B	700	15	15	15	15
175.080.056.2A	764	375.080.056.2A	800	15	15	15	15
175.080.056.2B	764	375.080.056.2B	800	15	15	15	15
175.090.056.2A	864	375.090.056.2A	900	15	15	15	15
175.090.056.2B	864	375.090.056.2B	900	15	15	15	15
175.100.056.2A	964	375.100.056.2A	1000	15	15	15	15
175.100.056.2B	964	375.100.056.2B	1000	15	15	15	15

TYPES 172 AND 372



Type no. without flange	L	Type no. with flange	L	X1	X2	X3	X4
172.070.056.2A	679	372.070.056.2A	700	15	30	30	15
172.070.056.2B	679	372.070.056.2B	700	15	30	30	15
172.080.056.2A	779	372.080.056.2A	800	15	30	30	15
172.080.056.2B	779	372.080.056.2B	800	15	30	30	15
172.090.056.2A	879	372.090.056.2A	900	15	30	30	15
172.090.056.2B	879	372.090.056.2B	900	15	30	30	15
172.100.056.2A	979	372.100.056.2A	1000	15	30	30	15
172.100.056.2B	979	372.100.056.2B	1000	15	30	30	15

TYPES 176 AND 376

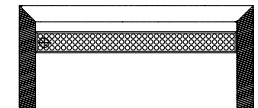

Type no. without flange	L	Type no. with flange	L	X1	X2	X3	X4
176.070.056.2A	694	376.070.056.2A	700	15	15	30	30
176.070.056.2B	694	376.070.056.2B	700	15	15	30	30
176.080.056.2A	794	376.080.056.2A	800	15	15	30	30
176.080.056.2B	794	376.080.056.2B	800	15	15	30	30
176.090.056.2A	894	376.090.056.2A	900	15	15	30	30
176.090.056.2B	894	376.090.056.2B	900	15	15	30	30
176.100.056.2A	994	376.100.056.2A	1000	15	15	30	30
176.100.056.2B	994	376.100.056.2B	1000	15	15	30	30

TYPES 173 AND 373



Type no. without flange	L	Type no. with flange	L	X1	X2	X3	X4
173.070.056.2A	679	373.070.056.2A	700	15	30	15	30
173.070.056.2B	679	373.070.056.2B	700	15	30	15	30
173.080.056.2A	779	373.080.056.2A	800	15	30	15	30
173.080.056.2B	779	373.080.056.2B	800	15	30	15	30
173.090.056.2A	879	373.090.056.2A	900	15	30	15	30
173.090.056.2B	879	373.090.056.2B	900	15	30	15	30
173.100.056.2A	979	373.100.056.2A	1000	15	30	15	30
173.100.056.2B	979	373.100.056.2B	1000	15	30	15	30

TYPES 177 AND 377

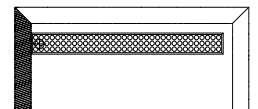

Type no. without flange	L	Type no. with flange	L	X1	X2	X3	X4
177.070.056.2A	679	377.070.056.2A	700	15	15	30	15
177.070.056.2B	679	377.070.056.2B	700	15	15	30	15
177.080.056.2A	779	377.080.056.2A	800	15	15	30	15
177.080.056.2B	779	377.080.056.2B	800	15	15	30	15
177.090.056.2A	879	377.090.056.2A	900	15	15	30	15
177.090.056.2B	879	377.090.056.2B	900	15	15	30	15
177.100.056.2A	979	377.100.056.2A	1000	15	15	30	15
177.100.056.2B	979	377.100.056.2B	1000	15	15	30	15

All dimensions in mm - see drawings overleaf

TYPES 174 AND 374



Type no. without flange	L	Type no. with flange	L	X1	X2	X3	X4
174.030.056.2A	264	374.030.056.2A	300	15	30	15	15
174.030.056.2B	264	374.030.056.2B	300	15	30	15	15
174.070.056.2A	664	374.070.056.2A	700	15	30	15	15
174.070.056.2B	664	374.070.056.2B	700	15	30	15	15
174.080.056.2A	764	374.080.056.2A	800	15	30	15	15
174.080.056.2B	764	374.080.056.2B	800	15	30	15	15
174.090.056.2A	864	374.090.056.2A	900	15	30	15	15
174.090.056.2B	864	374.090.056.2B	900	15	30	15	15
171.100.056.2A	964	374.100.056.2A	1000	15	30	15	15
171.100.056.2B	964	374.100.056.2B	1000	15	30	15	15

Gratings

Channels with round-hole grating:

xxx.xxx.xxx.xA

Channels with annular grating:

xxx.xxx.xxx.xB



COMBINABLE PARTS

Gratings

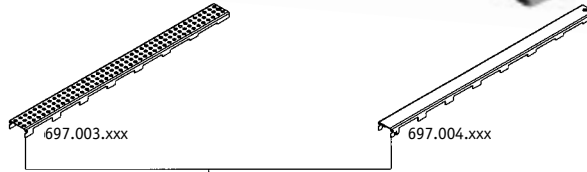

Frames

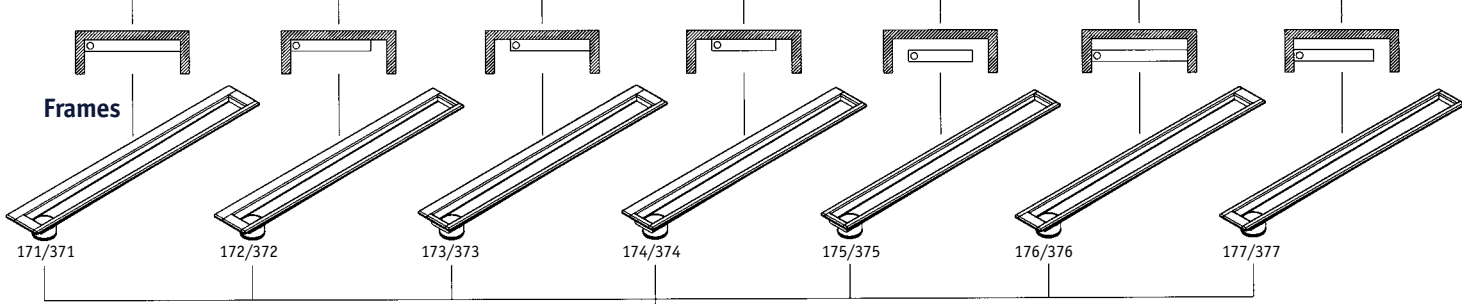

Flange/adaptor

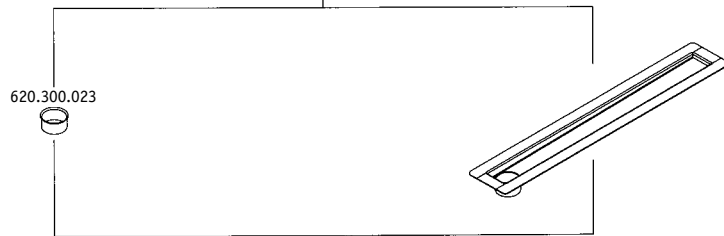

Lower parts/ Outlet parts

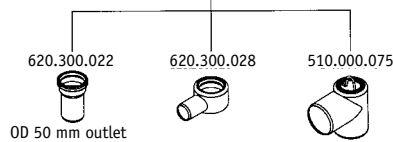

BLÜCHER WATERLINE SHOWER CHANNELS WITHOUT FLANGE:

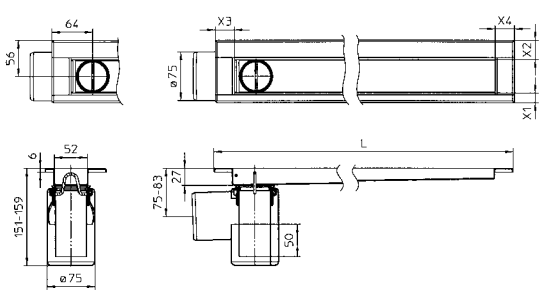

BLÜCHER WATERLINE SHOWER CHANNELS WITH FLANGE:

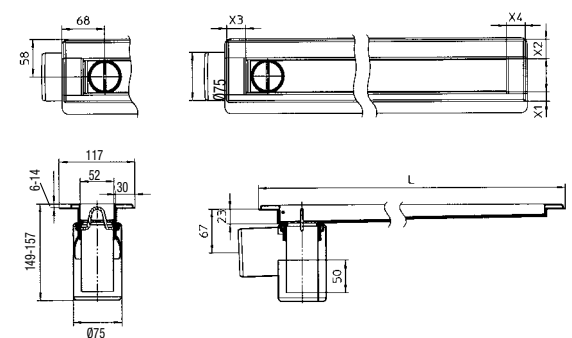

ACCESSORIES:



Removable water trap

Type no.	D1	D2	D3	H	Water seal height	Flow
510.000.075	50	75	75	120	50 mm	0,8 l/sec.

Outlet part

Type no.	D1	D2	D3	H
620.300.028	40	56	75	51



COMBINABLE PARTS

Gratings



Frames

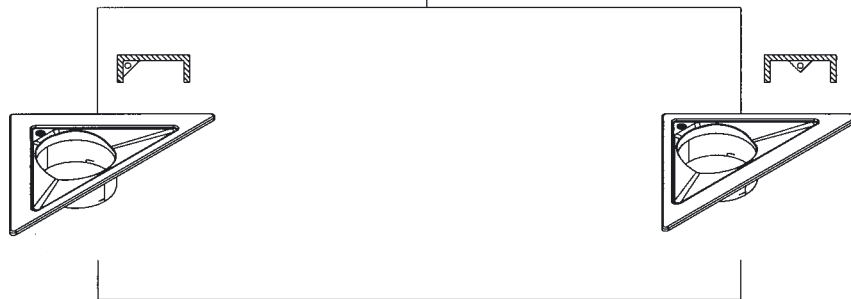

Water trap



Flange

Without flange

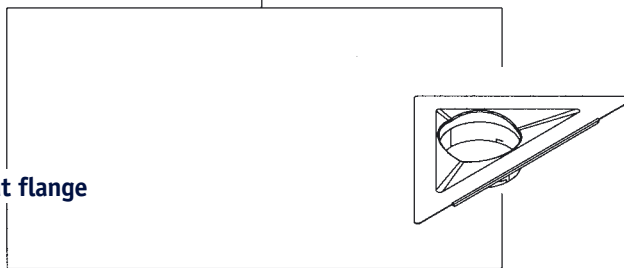

Lower parts

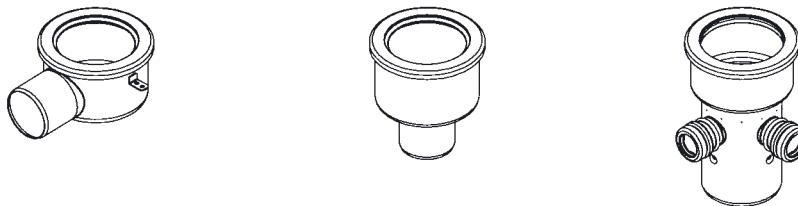

TRIANGLE DRAIN TYPES 110 AND 310

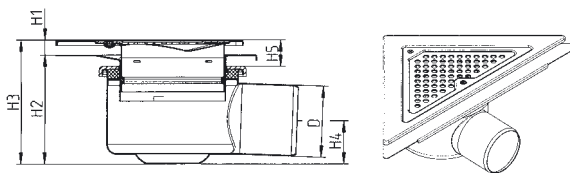

Type no.	Flange	Installation	D	H1	H2	H3	H4	H5	L1	L2	X1	X2	X3
110.360.075	No	Corner	75	-	-	115-130	45	12-27	277	388	30	30	15
310.360.075	Yes	Corner	75	6-21	113-128	119-149	45	16-46	277	388	30	30	15
110.370.075	No	Along wall	75	-	-	115-130	45	12-27	268	376	15	15	30
310.370.075	Yes	Along wall	75	6-21	113-128	119-149	45	16-46	268	376	15	15	30

TRIANGLE DRAIN TYPES 150 AND 350

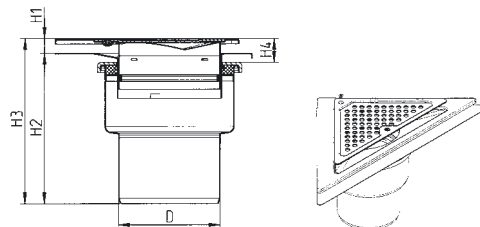

Type no.	Flange	Installation	D	H1	H2	H3	H4	L1	L2	X1	X2	X3
150.360.110	No	Corner	110	-	-	164-179	12-27	277	388	30	30	15
350.360.110	Yes	Corner	110	6-21	162-177	168-198	16-46	277	388	30	30	15
150.370.110	No	Along wall	110	-	-	164-179	12-27	268	376	15	15	30
350.370.110	Yes	Along wall	110	6-21	162-177	168-198	16-46	268	376	15	15	30

TRIANGLE DRAIN TYPES 155 AND 355

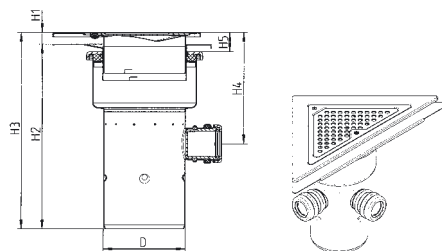

Type no.	Flange	Installation	D	H1	H2	H3	H4	H5	L1	L2	X1	X2	X3
155.360.110	No	Corner	110	-	-	250-265	136-151	12-27	277	388	30	30	15
355.360.110	Yes	Corner	110	6-21	248-263	254-284	140-170	16-46	277	388	30	30	15
155.370.110	No	Along wall	110	-	-	250-255	136-151	12-27	268	376	15	15	30
355.370.110	Yes	Along wall	110	6-21	248-263	254-284	140-170	16-46	268	376	15	15	30

ACCESSORIES

"0" grating for triangle drain

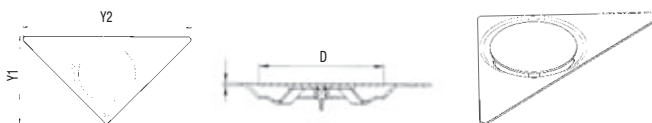

Type no.	D	Y1	Y2
620.300.027	92	141	272

Water trap

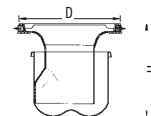

Type no.	H	Water seal height	D	Flow min.
502.052.110	93	52	108	0,8l/s

All dimensions in mm

INSTALLATION IN CORNER

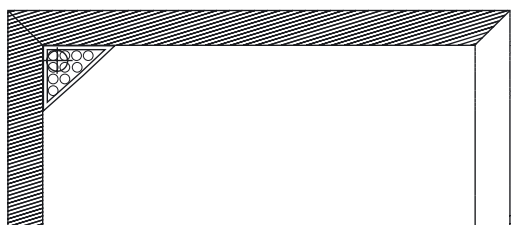

INSTALLATION ALONG WALL

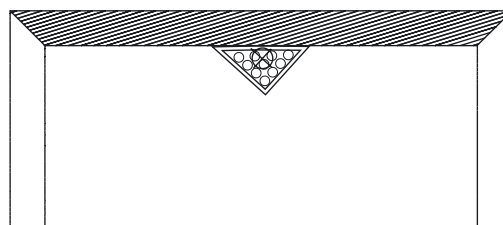

BLÜCHER

EuroPipe®

DRAINAGE PIPES AND FITTINGS



BLÜCHER

Domestic®

FLOOR DRAINS



BLÜCHER

Industrial®

FLOOR DRAINS



BLÜCHER

Marine®

DRAINAGE PRODUCTS



BLÜCHER

Channel®

LINEAR DRAINAGE

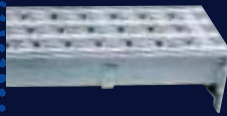

BLÜCHER

Pugdølvej 1 · 7480 Vildbjerg

Tlf. +45 99 92 08 00 · Fax +45 99 92 08 30

export@blucher.dk · www.blucher.com

BLÜCHER, founded in 1965, is a leading European manufacturer of stainless steel drainage systems. The BLÜCHER products exceed the demands of the strictest user requirements for commercial, industrial and marine applications worldwide.

